

Watch this video:
https://youtu.be/IIY_DUp49-4
"Israel Misuses the Ark" (5:00)
By Cartoonworks

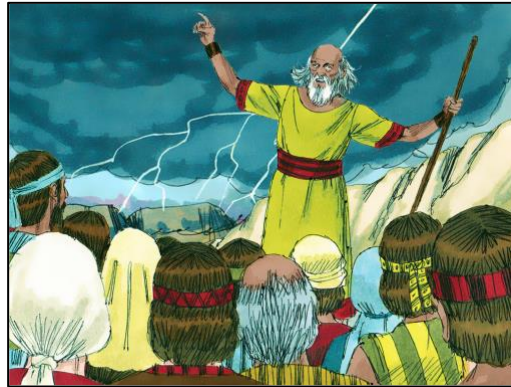

SAMUEL – ISRAEL'S LAST JUDGE (1st Samuel 4 – 7)



The Bible says that Samuel was the last Judge. Even when Samuel was a young boy, God had talked to him. God told Samuel that Eli and his sons would not be priests for long.

Eli was the High Priest. His sons were priests too, but they were wicked. They took the Ark of the Covenant out of the Tabernacle and carried it into battle. That was a bad thing to do. The Ark is not a "good-luck charm." The cruel Philistines won the battle. They captured the Ark! Eli's sons died. When Eli heard it, he fell off his chair and died too.



The Philistines took the Ark of the Covenant from city to city. In every city many people got sick and died. The Philistines worshipped the idol Dagon that looked like half fish and half man. The ark was put in Dagon's temple. The One True God caused Dagon to fall into pieces.

The Philistines finally put the Ark on a cart. Cows pulled it back to the Israelites. It stayed protected in a man's house for 20 years. The Ark is God's special seat. It is not a lucky charm to carry around.

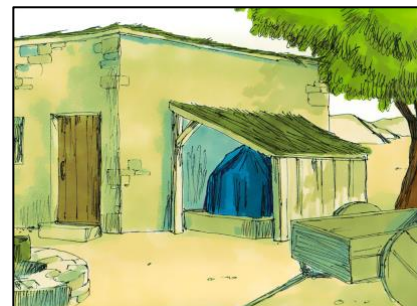

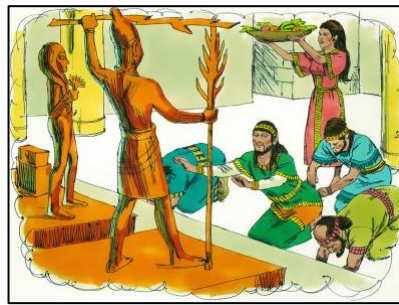

The Israelites began to worship idols. The cruel Philistine soldiers attacked again.

So, the people decided it was time to turn back to God. Samuel told them they must destroy their idols and worship the One True God. The people listened to Samuel. They broke down their idols.

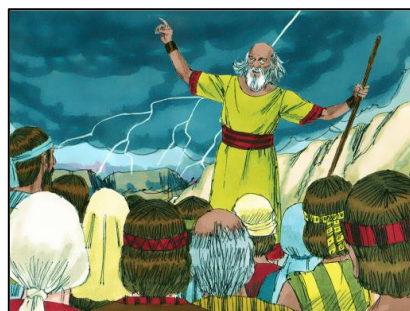
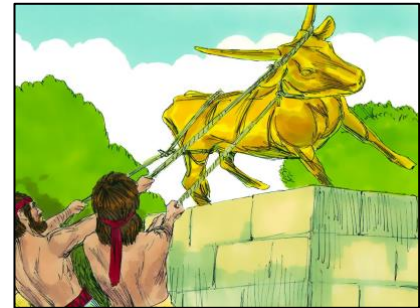

Samuel prayed for God to help them. God answered Samuel's prayer. He sent powerful thunder. The sky was filled with thunder that was very loud and scary!

The Philistine soldiers were confused and scared. The Israelite army defeated the Philistines.

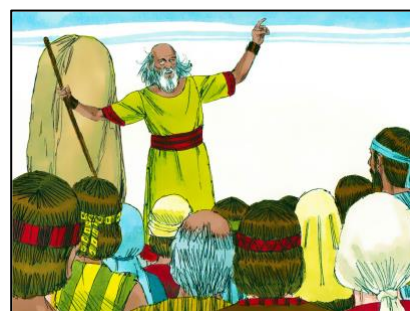

Samuel wanted the people to remember what God had done. So, he set up a rock monument. He called it "Ebenezer." The word Ebenezer means "The Lord helped us."

Samuel was a good Judge. He traveled around all the Israelite tribes. He helped them to trust and obey the One True God.

We don't need an Ark of the Covenant any more.
God's presence isn't with us on a special seat. His Son Jesus is with us always.

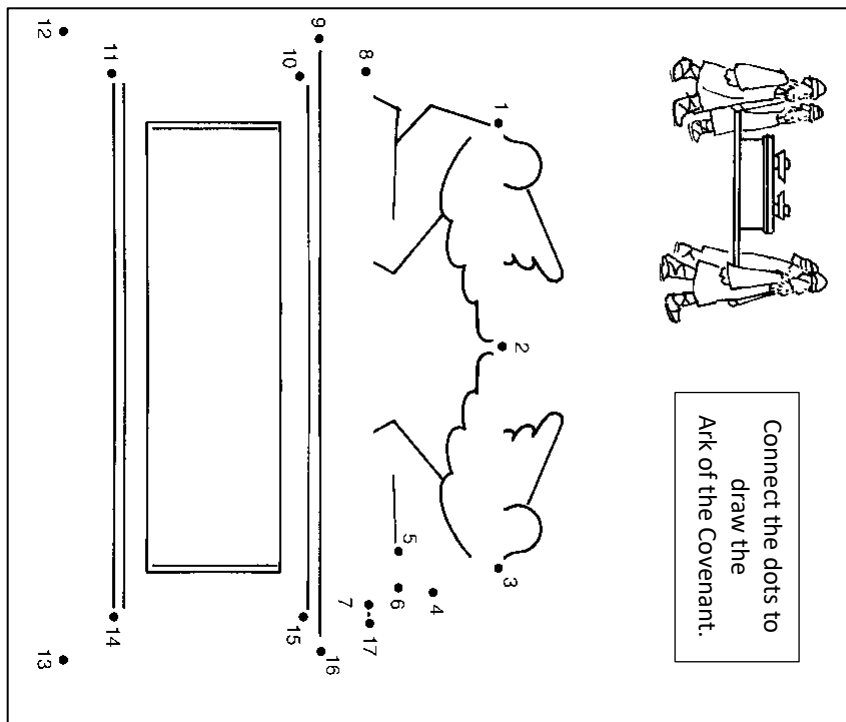

Connect the dots to draw the Ark of the Covenant.

This activity consists of a dot marker drawing of the Ark of the Covenant. The drawing is divided into several sections, each with numbered dots for tracing. The top section shows two figures standing on either side of a table. The middle section shows the main body of the ark with wings and a door. The bottom section shows the base of the ark. The dots are numbered from 1 to 17.

When Eli heard the news,
he fell backward off his chair.

Follow the maze.

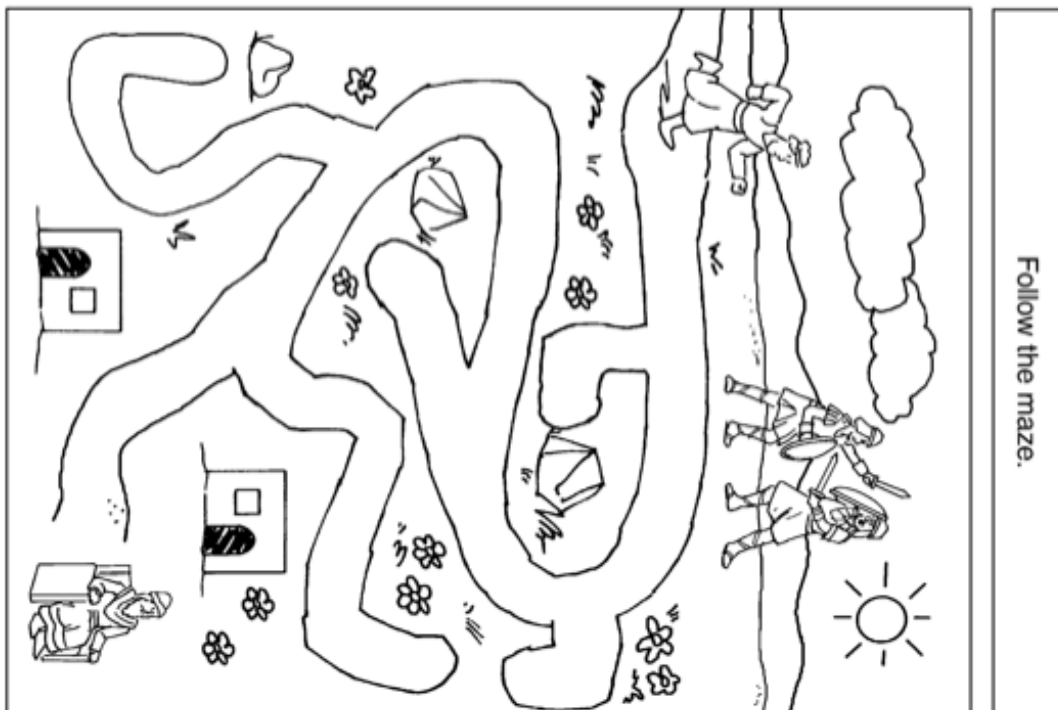

This section contains a maze activity. At the top, there is a biblical illustration of Eli falling backward off his chair. Below the illustration is a large, winding maze. The maze starts at the top right and ends at the bottom left. The maze is surrounded by various symbols, including a sun, clouds, flowers, and a house. The maze is designed to be followed from the start point to the end point.

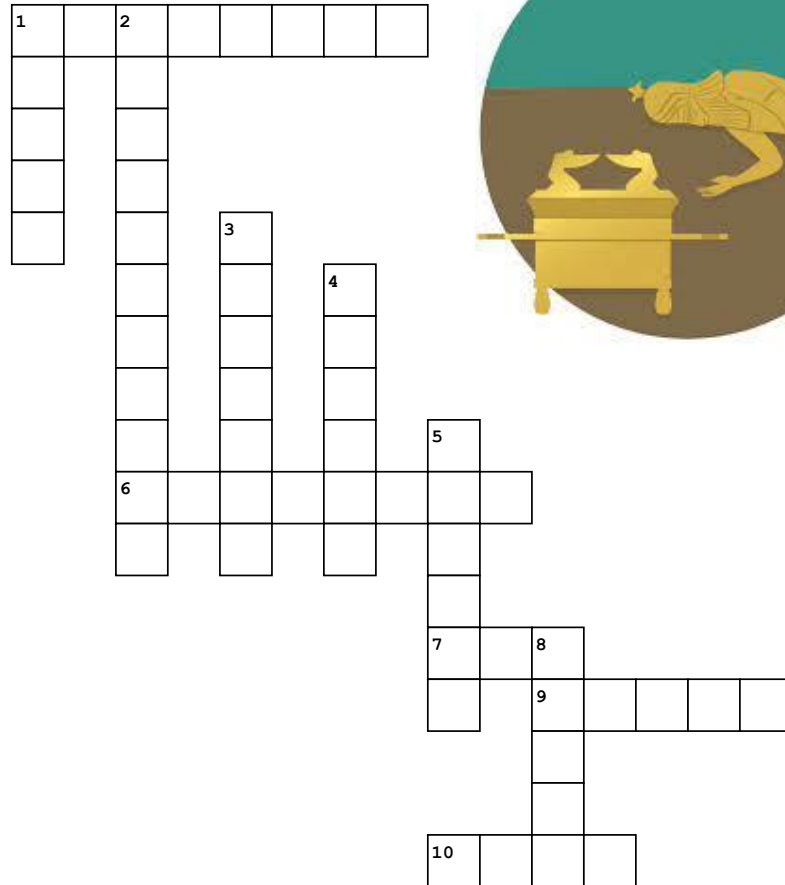

Across

- 1. Ark of the Covenant was _____.
- 6. Samuel's rock monument
- 7. The High Priest
- 9. The Philistines' idol
- 10. Dagon was half man and half _____.

Down

- 1. Eli fell off of his _____ and died
- 2. Enemies of the Israelites
- 3. God sent loud _____.
- 4. Ebenezer means "God _____ us."
- 5. The last judge
- 8. The Israelites broke down these