

Video:
https://youtu.be/IIY_DUp49-4
 "Israel Misuses the Ark"
 By Cartoonworks

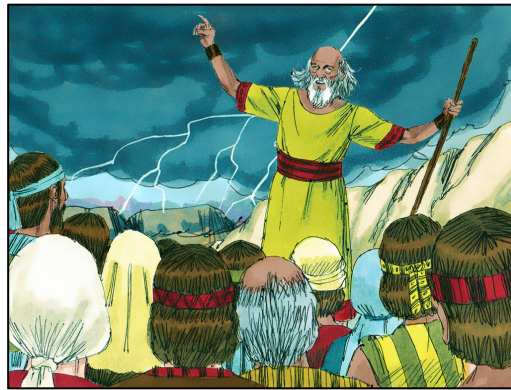

Lesson #16: SAMUEL – ISRAEL’S LAST JUDGE (1st Samuel 4 – 7)



The Bible says that Samuel was the last Judge. Even when Samuel was a young boy, God had talked to him. God told Samuel that Eli and his sons would not be priests for long.

Eli was the High Priest. His sons were priests too, but they did not truly follow God. They took the Ark of the Covenant out of the Tabernacle and carried it into battle. That was a bad thing to do. The Ark is not a “good-luck charm.” The cruel Philistines won the battle. They captured the Ark! Eli’s sons died. When Eli heard it, he fell off his chair and died too.



The Philistines took the Ark of the Covenant from city to city. In every city many people got sick and died. The Philistines worshipped the idol Dagon that looked like half fish and half man. The ark was put in Dagon’s temple. The One True God caused Dagon to fall into pieces.

The Philistines finally put the Ark on a cart. Cows pulled it back to the Israelites. It stayed protected in a man’s house for 20 years. The Ark is God’s special seat. It is not a lucky charm to carry around.

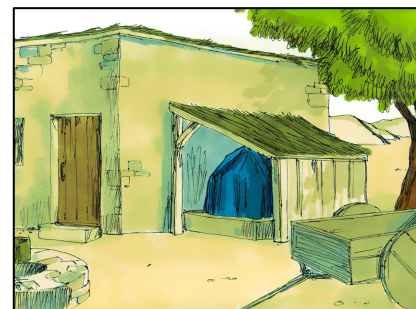



The Israelites continued to worship idols. The cruel Philistine soldiers attacked again.

So, the people decided it was time to turn back to God. Samuel told them they must destroy their idols and worship the One True God. The people listened to Samuel. They broke down their idols.

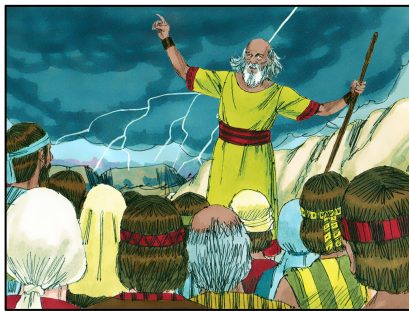
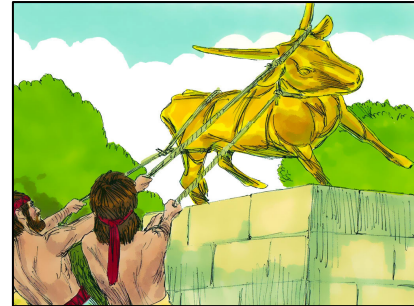

Samuel prayed for God to help them. God answered Samuel's prayer. He sent powerful thunder. The sky was filled with thunder that was very loud and scary!

The Philistine soldiers were confused and scared. The Israelite army defeated the Philistines.

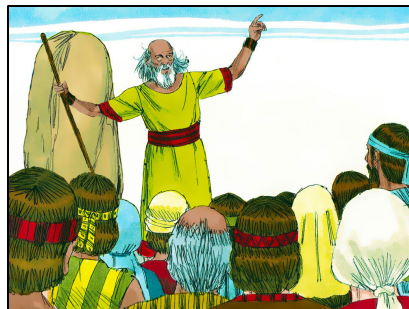

Samuel wanted the people to remember what God had done. So, he set up a stone monument. He called it "Ebenezer." The word Ebenezer means "The Lord helped us."

Samuel was a good Judge. He traveled around all the Israelite tribes. They learned that it was important to obey God, not just carry the Ark. Samuel helped them to trust the One True God.

Now that Christ has come, we don't need an Ark of the Covenant anymore. God isn't just with us on a special seat. If we trust and obey God, Son Jesus is with us always. Even after Jesus went back to Heaven, he sent the Holy Spirit to live in our hearts. No one can ever take away from us!



PRIMARY GRADES ACTIVITY

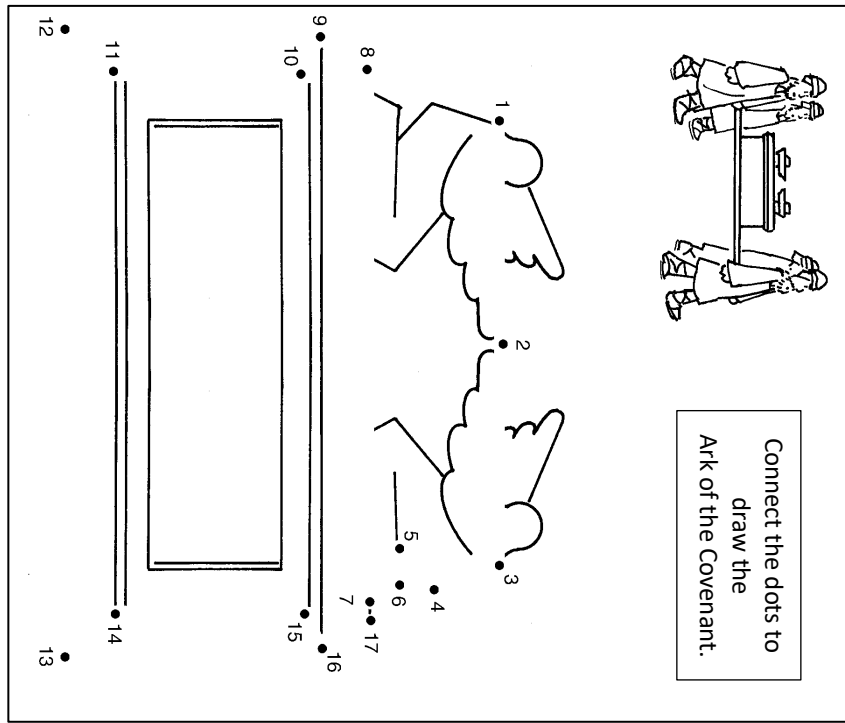

Connect the dots to draw the Ark of the Covenant.

When Eli heard the news,
he fell backward off his chair.

Follow the maze.

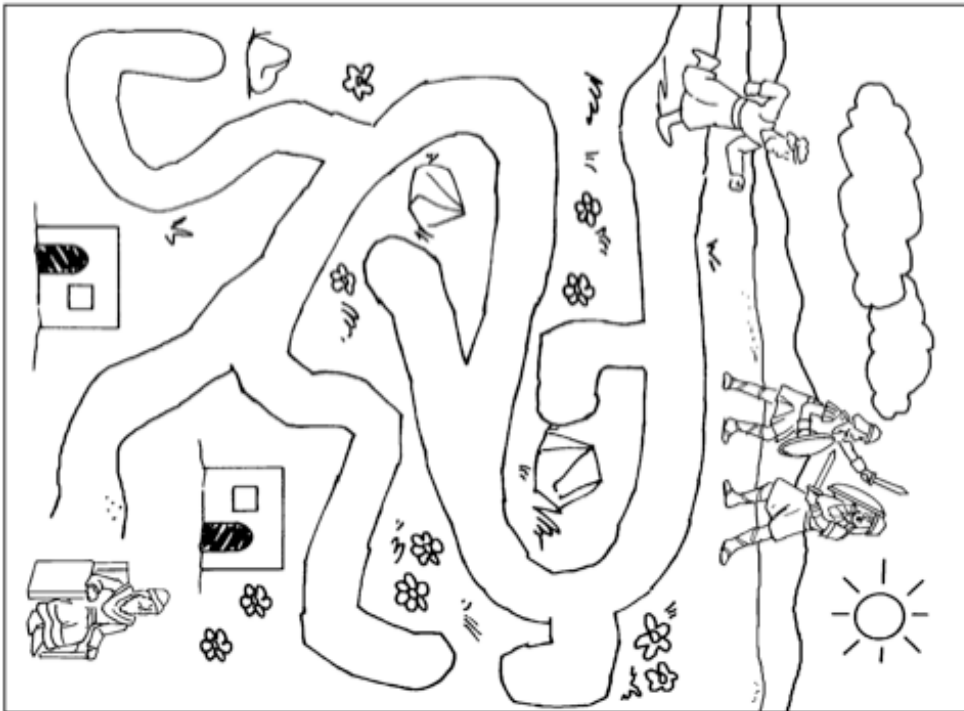

UPPER GRADES ACTIVITY
SAMUEL CROSSWORD PUZZLE

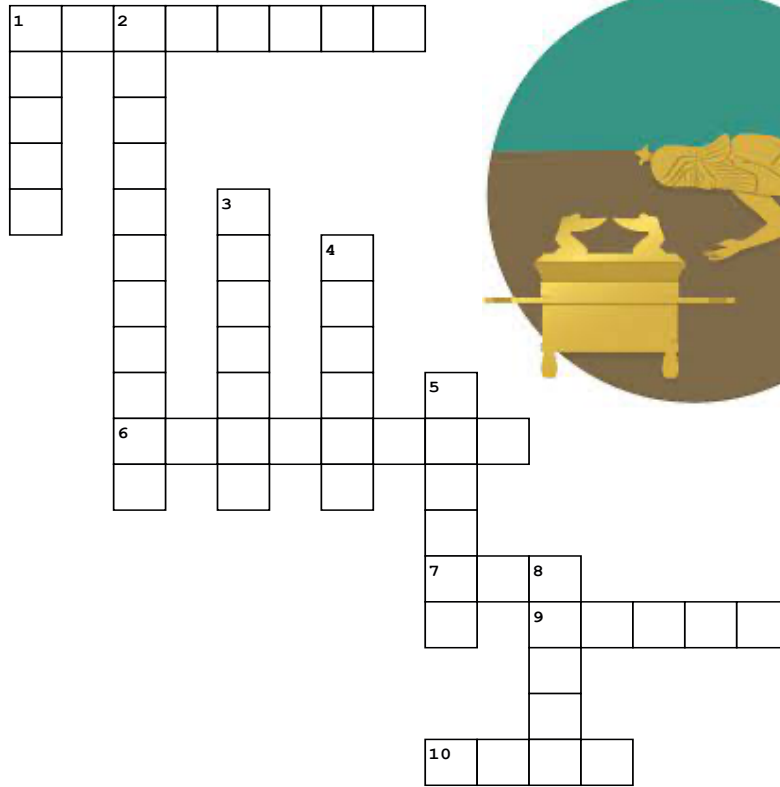

Across

- 1. Ark of the Covenant was _____.
- 6. Samuel's rock monument
- 7. The High Priest
- 9. The Philistines' idol
- 10. Dagon was half man and half _____.

Down

- 1. Eli fell off of his _____ and died
- 2. Enemies of the Israelites
- 3. God sent loud _____.
- 4. Ebenezer means "God _____ us."
- 5. The last judge
- 8. The Israelites broke down these

Think About This:



- 1. Israel learned they must _____ God, not just carry the Ark.
- 2. Samuel told the people to get rid of false _____.
- 3. Samuel prayed, and God helped Israel win the _____.
- 4. Why do you think it is important for us to remember that **God helps us?** _____